



23.rd INTERNATIONAL ECONOMIC FAIR MOSTAR 2019.

30.03. - 04.04.2020.

Mostarski sajam Inc.
Rodoč bb, 88000 Mostar, BiH
Tel.: + 387 (0) 36 350 080; 350 194
Fax: + 387 (0) 36 350 134; 350 323
e-mail: info@mostar-fair.com
www.mostar-fair.com

05.04.- 09.04.2022.

We give a 10% discount for early-bird registrations before 31.12.2021.

Exhibition program:

International Economic Fair

The biggest and the most important economic event in B&H. The Fair creates a pleasant business environment, enables business networking of exhibitors and visitor and hosts various events.



- Automobile industry
- Construction industry
- Agriculture and food industry
- Wood and lumber industry

- Utility equipment
- Electrical and chemical industry
- Medical equipment and cosmetics
- Telecomm and technology
- Banking and insurance
- Metal production and processing industry

Tourism Fair Mostar

A place for tourist offer and tourist agencies, tour operators, destinations and visitors, a place for presentation and promotion of wines and wine-industry products.



- Tourist communities
- Tourist agencies
- Wine cellars and boutiques
- Hotels and motels

- Tourist destinations
- Restaurants and catering
- Tourist services
- Cities and cantons
- Sports and tourist programs
- Tradicional products
- Supporting industry

General information:

- Date:** 05.04.- 09.04.2022.
- Venue:** Mostar
- Opening ceremony:** Tuesday, 05.04.2022. at 11:00h
- Work hours:** 10:30 - 18:30
- Closing:** Saturday 09.04.2022. at 16:00
- Dismanteling of stand:** Saturday, 09.04.2022. - 18:00 to 22:00
Sunday, 10.04.2022. - 07:00 to 18:00
- Stand security:** Exhibitors are to be present at their stands during the equipping and arranging, from 7:00 a.m. to 21:00 p.m. During the Fair days, exhibition stands are secured by the Organizer every day from 19:00p.m. to 10:00a.m. next day.
For any possible lost property there will not be any compensation until the time of loss is determined by the Organizer and the Fair Security Staff.
- Additional events:** Conferences, events and round tables with relevant representatives from B&H institutions, interesting for both home and international partners of the B&H market. VIP guests, representatives of the Government, ministries, from all levels of authorities from B&H, Region and participating countries.

Payment and freight:

Payment is to be done through the following banks **UniCredit bank d.d. Mostar**
Žiro račun: 3381002201728235
Devizni račun: 7100-48-06-15678-5
Za plaćanje iz inozemstva SWIFT UNCRBA22.

NLB banka d.d. Tuzla
IBAN BA 391327010166749934 forreign currency
account 101667499 swiftTBTUBA22

Payment deadline: 29.03.2022.

Freight house: **INTERAGENT d.o.o. Mostar**
tel.: + 387 36 350 242

Organizer: **Mostarski sajam d.o.o.**, Rodoč bb, 88000 Mostar, Bosna i Hercegovina

Data and personal information submitted by this application form will be fed into Mostar Fair computer system, for processing of the registration forms of exhibitors at Mostar Fair. Submitting this data to Mostar Fair automatically approves their use in communicating with you, including electronic mail, aiming at providing you with information on our activities and services. Your data can be updated at any time, as well as cancelled by sending an email to: kljenti@mostarski-sajam.com



23.rd INTERNATIONAL ECONOMIC FAIR MOSTAR 2019.

30.03. - 04.04.2020.

Mostarski sajam Inc.
Rodoč bb, 88000 Mostar, BiH
Tel.: + 387 (0) 36 350 080; 350 194
Fax: + 387 (0) 36 350 134; 350 323
e-mail: info@mostar-fair.com
www.mostar-fair.com



22.nd INTERNATIONAL ECONOMIC FAIR MOSTAR 2022.

05.04.- 09.04.2022.

Mostarski sajam Inc.
Rodoč bb, 88000 Mostar, BiH
Tel.: + 387 (0) 36 350 080; 350 194
Fax: + 387 (0) 36 350 134; 350 323
e-mail: info@mostar-fair.com
www.mostar-fair.com

REGISTRATION FORM

Form B

Info about exhibitors:

Company:

Bank account no.:

VAT No.:

Address:

tel.:

fax :

e-mail:

www.

contact person

tel.:



e-mail:

Business description (for the Fair Catalogue)

Order of a Pavillion Exhibition area: (implies marked layout, with no utility connections)

	Unarranged pavillion exhibition area	price	l order	DISCOUNT 10% on the area of 50-99 m ² 15% on the area of 100-179 m ² 20% on the area of 180-299 m ² 30% on the area of 300 m ²
1.	in a row (one side open), min. 12m ²	57 € /m ² m ²	
2.	corner (two sides open), min. 24m ²	62 € /m ² m ²	
3.	front (three sides open), min. 50m ²	65 € /m ² m ²	
4.	insular (four sides open), min.120m ²	67 € /m ² m ²	

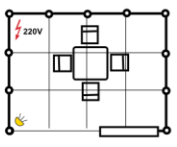
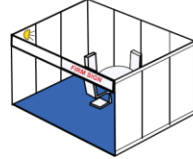
Exhibition stand equipping: (Order of stand equipping - mark with X)

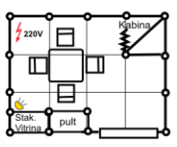
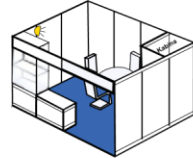
<input type="checkbox"/> BASIC STAND ARRANGEMENT: m ² 19€ /m ²	 	Includes: partition walls (Octanorm construction - colored white in the picture) • table • four chairs • carpet • reflector electricity connection	 Note: Board with inscription doesn't make part of landscaping and is ordered separately like all the other equipment and technical services <i>/Check Form D/</i>
<input type="checkbox"/> STANDARD ARRANGEMENT m ² 29€ /m ²	 	Includes: partition walls (Octanorm construction - colored white in the picture) • table and four chairs • carpet • reflector counter • tall glass show-case • curtain-enclosed booth • electricity connection	

ARRANGEMENT ACCORDING TO SPECIFIC PROJECTS



Exhibition area ordered with a preliminary design will be created in cooperation with the exhibitor. Price will be determined according to the project specification.

Note:

If the stand design is not ordered from Mostar Fair, the exhibitor is to ask for permission to build their own exhibition area. This permit is approved and issued by Mostar Fair Project Office, at the rate of 2,5 €/m². Formal request for construction of a uniquely designed exhibition area is submitted to Mostar Fair (Head Office), Rodoč bb, 88.000 Mostar, B&H or to email biro@mostarski-sajam.com

Registration tax

catalogue entry (business description and logo) 75€

lump sum for electricity 1€ /m²



23.rd INTERNATIONAL ECONOMIC FAIR MOSTAR 2019.

30.03. - 04.04.2020.

Mostarski sajam Inc.
Rodoč bb, 88000 Mostar, BiH
Tel.: + 387 (0) 36 350 080; 350 194
Fax: + 387 (0) 36 350 134; 350 323
e-mail: info@mostar-fair.com
www.mostar-fair.com



22.nd INTERNATIONAL ECONOMIC FAIR MOSTAR 2022.

05.04.- 09.04.2022.

Mostarski sajam Inc.
Rodoč bb, 88000 Mostar, BiH
Tel.: + 387 (0) 36 350 080; 350 194
Fax: + 387 (0) 36 350 134; 350 323
e-mail: info@mostar-fair.com
www.mostar-fair.com

Order of Pavillion exhibition area:

Form C

Info about exhibitors:

Company:

Bank account no.:

VAT No.:

Address:

tel.:

fax :

e-mail:

www.

contact person

tel.:

e-mail:

Business description (for the Fair Catalogue)

Order of outdoor open exhibition area	price	I order	dimensions
1. area up to 50m ² (min.20m ²)	25€ /m ² m ²	width _____ length
2. area up to 51m ² - 120m ²	20€ /m ² m ²	width _____ length
3 area from 121m ²	15€ /m ² m ²	width _____ length

Order of tents, pagodas and containers

No.	Service description	pieces	Price / EUR (€)
1.	Tent 10x10m, 10x20m (with foundation + carpet)		12 / m2
2.	Pagoda (with foundation + carpet)		18 / m2
3.	Container 6,05x2,44x2,61m		154 / kom

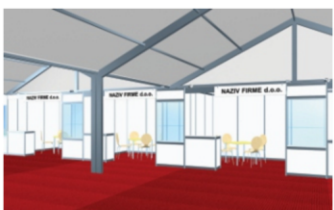

NOTE:
Offices can be formed in the tent / optionally / by order

Order:
Mark X: Dimenzije ureda: širina.....m dužina.....m
 Office Space
 Office dimensions: width:.....m length:.....m
 Office entrance Curtain Door

Order of technical favours

No	Service description	pieces	Price / EUR (€)
1.	Elect connection 220V to 5kW		75
2.	Elect connection 220V to 10kW		82
3.	Elect connection 380V to 5kW		122
4.	Water connection supply and drainage		131
5.	Wireless		60
6.	Cleaning of the exhibition area /m ²		1
7.	Forklift truck services		48

Obligatory taxes and final notes

Registration tax catalogue entry (business description and logo) 75€
 lump sum for electricity 1€/m²

By signing and verifying this form/contract we irrevocably order selected services and accept conditions and regulations for participation at the Fair.

_____ date Stamp and signature of organizer

_____ date Stamp and signature of exhibitor

2022.

N.b	Technical service description	UR (€)	Pieces
1.	Electrical connection 220V to 5kW	75	
2.	Electrical connection 220V to 10kW	82	
3.	Electrical connection 380V to 10kW	122	
4.	Connection for water supply and drainage (sink, machine, coffee machine, icemaker, ...)	131	
5.	Wireless Internet (WiFi)	60	

N.b	Technical service description	UR (€)	Pieces
6.	Cleaning of exhibition space /m ²	1	
7.	Forklift service (per hour of operation)	48	
8.	Car-lift service (per hour of operation)	48	
9.	Work platform service (per hour of operation) (self-propelled jointed work platform for elevated work)	48	
10.			

STAND NB. PAVILION

Signing and certification of this application-contract irrevocably we order these selected services and accept the conditions and general rules of participation.

*** prices do not include VAT**

Filled in by the organizer:

Filled in by the client

_____ date Stamp and signature of organizer















_____ date Stamp and signature of exhibitor

















05.04.- 09.04.2022.

D. ORDER OF ADDITIONAL EQUIPMENT

Form D

D. ADDITIONAL EQUIPMENT

N.b.	Additional equipment description	EUR (€)	Pieces
1.	 Partition rock dim. 100cm, 70cm, 50cm, v-250cm	20	
2.	 Glass with venezier dim. 100cm, v-250cm	45	
3.	 High glass cabinet dim. 100x100cm, 100x50cm, h 250cm	78	
4.	 Low glass showcase dim. 100x100cm, 100x50cm, h-100cm	47	
5.	 High glass 1/4 circles dim. 70x70cm, 50x50cm, h-250cm	100	
6.	 Info desk dim. 100x50cm, h-75cm	35	
7.	 Info desk dim. 100x50cm, h-100cm	43	
8.	 Arch info desk rounded dim. 200x50cm, h-100cm	85	
9.	 Arch info 1/4 circle dim. 140x50cm, h-100cm	55	
10.	 Info desk fluorescent dim. 107x50cm, h-100cm	80	
11.	 Double height table dim. 100x50cm, h-120cm	61	
12.	 Podests of all heights dim. 100x100cm, 100x50cm, h-20, 50, 80cm	34	
13.	 Roto plexi cube and lens 100x100cm, h-80	165	
14.	 Advertising box dim. 100x100cm, 70x70cm, h-100, 70, 50cm	75	
15.	 Advertising box fluorescent dim. 100x100cm, 70x70cm, h-100, 70, 50cm	100	
16.	 Display miscellaneous dim. 100cm, 70cm, 50cm, h-250cm	60	
17.	 Display miscellaneous fluorescent dim. 100cm, 70cm, 50cm, h-250cm	112	
18.	 Door dim. 100cm, h-200cm	49	
19.	 Curtain dim. 100cm, h-200cm	32	
20.	 Refrigerator	62	
21.	 Mini kitchen	220	

N.b.	Additional equipment description	EUR (€)	Pieces
22.	 Table	26	
23.	 Chair	12	
24.	 Bar table	27	
25.	 Bar chair	23	
26.	 Three storey shelf dim. 100x50cm, h-250cm	75	
27.	 Console shelf dim. 100x30cm, 200x30cm	18	
28.	 Book shelf	9	
29.	 Hanger	13	
30.	 Sink	52	
31.	 Key locker	49	
32.	 Carpet /m ²	4	
33.	 Reflector halogen 300W	15	
34.	 LED Reflector 150W	46	
35.	Painting walls /m ²	10	
36.	Floor in laminate /m ²	28	
37.	Stand upgrade	32	
38.	 Table sign/logo	42	
39.	 Rental of LCD screen	100	
40.	 Structure 1m ²	26	
41.			
42.			

NOTE: Additional ordered equipment is not included in the stated price of equipping the stand.



23.rd INTERNATIONAL ECONOMIC FAIR MOSTAR 2019.

30.03. - 04.04.2020.

Mostarski sajam Inc.
Rodoč bb, 88000 Mostar, BiH
Tel.: + 387 (0) 36 350 080; 350 194
Fax: + 387 (0) 36 350 134; 350 323
e-mail: info@mostar-fair.com
www.mostar-fair.com

D. ORDER OF TECHNICAL SERVICES



22.nd INTERNATIONAL ECONOMIC FAIR MOSTAR 2022.

05.04.- 09.04.2022.

Mostarski sajam Inc.
Rodoč bb, 88000 Mostar, BiH
Tel.: + 387 (0) 36 350 080; 350 194
Fax: + 387 (0) 36 350 134; 350 323
e-mail: info@mostar-fair.com
www.mostar-fair.com

E. SERVICES OF MARKETING

Form E

E1. CLIENT DATA

Company:

Bank account no.: VAT No.:

Address:

tel.: fax :

e-mail: www.

contact person tel.: e-mail:

Business description (for the Fair Catalogue)
(See form E)

E2. TICKETS AND HOSTESS



N.b.	Service description	EUR (€)	Pieces
1.	Permanent ticket	12	
2.	Permanent ticket for parking	12	
3.	Daily ticket	2,5	
4.	Daily ticket for parking	2,5	
5.	Stamp on front side of ticket	500	



N.b.	Service description	EUR (€)	Pieces
1.	Hostess/day	40	
	All days of fair		
	<input type="checkbox"/> 1 <input type="checkbox"/> 2 <input type="checkbox"/> 3 <input type="checkbox"/> 4 <input type="checkbox"/> 5		
	<input type="checkbox"/> <input type="checkbox"/> <input type="checkbox"/> <input type="checkbox"/> <input type="checkbox"/>		
	<input type="checkbox"/> <input type="checkbox"/> <input type="checkbox"/> <input type="checkbox"/> <input type="checkbox"/>		

E1. FAIR'S CATALOGUE (NAME, LOGO OF THE COMPANY)

E2. FAIR'S RADIO

FAIR RADIO



N.b.	Service description	EUR (€)	Pieces
1.	Radio commercial 20 sec/10x daily	25	
2.	Radio commercial 20 sec/10x daily - all days of fair	100	
3.	Advertising video wall 1min/5x a day	50	
4.	Advertising video wall 1min/5x a day - all days of fair	150	



PLEASE DELIVER ALL DATA FOR NECESSARY ENTRY IN A CATALOGUE (NAME, LOGO OF THE COMPANY, ADDRESS, SERVICE, CONTACT) AND ORDERS OF OTHER COMMERCIAL SERVICES IN ONE OF THE FORMATS: JPG, PDF, CDR AT LEAST TO 22.03.2022 FINAL SETTLEMENT DELIVER THROUGH E-MAIL.

STAND NB.

PAVILION

Signing and certification of this application-contract irrevocably we order these selected services and accept the conditions and general rules of participation.

* prices do not include VAT

Filled in by the organizer:

Filled in by the client



23.rd INTERNATIONAL ECONOMIC FAIR MOSTAR 2019.

30.03. - 04.04.2020.

Mostarski sajam Inc.
Rodoč bb, 88000 Mostar, BiH
Tel.: + 387 (0) 36 350 080; 350 194
Fax: + 387 (0) 36 350 134; 350 323
e-mail: info@mostar-fair.com
www.mostar-fair.com

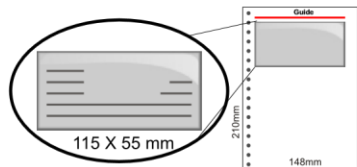

Business card dimension: 115x55mm

Space (business card) for posting the data of the company of exhibitor (logo, address, contacts, service description).

Your co-exhibitors will be led into without extra charge. Correct data of co-exhibitors is responsibility of exhibitor.

N.b.	Service description	EUR (€)	Pieces
1.	Cover first inside side 1/1, color	200	
2.	Cover last page 1/1, color	250	
3.	Cover last inside page 1/1, color	150	
4.	Daily ticket for parking	110	
5.	Stamp on front side of ticket	160	

E4 COMMERCIAL BILLBOARD



N.b.	Service description	EUR (€)	Pieces
1.	Commercial banner on fasade 800x800 cm	1300	
2.	Commercial banner on fasade 600x800 cm	1035	
3.	Commercial banner on fasade 800x400 cm	740	
4.	Commercial banner on fasade 800x300 cm	618	
5.	Commercial banner on fasade 300x800 cm	618	
6.	Mast in the circle of the fair	150	
7.	Jumbo billboard 400x300 cm	210	
8.	Jumbo billboard 330x220 cm	150	
9.	Hanging banner in the pavilion 150x600cm (both side painted)	300	
10.	Hanging banner in the pavilion 300x600cm (both side painted)	540	



22.nd INTERNATIONAL ECONOMIC FAIR MOSTAR 2022.

05.04.- 09.04.2022.

Mostarski sajam Inc.
Rodoč bb, 88000 Mostar, BiH
Tel.: + 387 (0) 36 350 080; 350 194
Fax: + 387 (0) 36 350 134; 350 323
e-mail: info@mostar-fair.com
www.mostar-fair.com

orm

EXHIBITION HALLS

Customer:

Company:

Bank account:

address:

tel.:

e-mail:

VAT No:

Contact person:

fax :

www.

Title of the presentation:



**23.rd INTERNATIONAL ECONOMIC FAIR
MOSTAR 2019.**
30.03. - 04.04.2020.

Mostarski sajam Inc.
Rodoč bb, 88000 Mostar, BiH
Tel.: + 387 (0) 36 350 080; 350 194
Fax: + 387 (0) 36 350 134; 350 323
e-mail: info@mostar-fair.com
www.mostar-fair.com

HALL S

No	Service description	EUR (€)	Date of presentation	Time of presentation
1.	Hall No.1 with 30 seats / hour	75		
2.	Hall No.3 with 80 - 100 seats / hour	75		
3.	Hall No.4 with 60 - 80 seats / hour	75		
4.	Conference hall / hour	200		

TEHNIICAL EQUIPMENT

Mark with X

- | | | | | | |
|--------------------------|---|-------------|--------------------------|--|-----------------|
| <input type="checkbox"/> | Rent of multimedia tehcnical support
RFC FORUM 600, digital conference and discussion system, 1+9
RFC ART SYSTEM wiring for sound in the Conference hall
Video projector in the Conference hall EIKI 4000 Ansi Lm Roll screen prescreen 3m diagonal
Roll screen prescreen 3 m diagonal
Body pack microphone set - additional wireless mic
PC Laptop, monitoring and network
Technical support team - 3 persons | 500 EUR (€) | <input type="checkbox"/> | Wiring for sound - public address system in the hall | 100 EUR (€) |
| <input type="checkbox"/> | | | <input type="checkbox"/> | Simultaneous interpretation equipment for 100 participants | 450 EUR (€) |
| <input type="checkbox"/> | | | <input type="checkbox"/> | LCD rent/day | 25 EUR (€) |
| <input type="checkbox"/> | | | <input type="checkbox"/> | Hostess with knowledge of one foreign language | 60 EUR (€)/day |
| <input type="checkbox"/> | | | <input type="checkbox"/> | Interpreting service (by arrangement) | |

- Catering (negotiable)
- Flower arrangement (small) 25EUR (€)
- Flower arrangement 35 EUR (€)

*** VAT not included in prices**

By signing and verifying this form/contract we irrevocably order selected services and accept conditions and regulations for participation at the Fair.

Filled in by the organizer:

Pavillion No. _____ Stand No. _____

_____ date

_____ Stamp and signature of organizer

2022.

Filled in by the exhibitor

_____ date

_____ Stamp and signature of exhibitor



23.rd INTERNATIONAL ECONOMIC FAIR MOSTAR 2019.

30.03. - 04.04.2020.

Mostarski sajam Inc.
Rodoč bb, 88000 Mostar, BiH
Tel.: + 387 (0) 36 350 080; 350 194
Fax: + 387 (0) 36 350 134; 350 323
e-mail: info@mostar-fair.com
www.mostar-fair.com

05.04.- 09.04.2022.

EXHIBITOR WHO MAKES THE STAND INDEPENDENTLY

Form G

FAIR
MANIFESTATION

Stand No.

Pavilion

G1. INTRODUCTORY NOTES:

Exhibitor who makes the stand independently and any exhibitor, who is hired for building the stand, **are obliged** to the Fair's project bureau to deliver the project of the stand for clearance at least **two days** before building the stand.

Projects are delivered by e-mail only on: biro@mostarski-sajam.com in pdf, and **must contain**:

- Name of exhibitor and work exhibitors with person for contact with data:
- and technical description of stand with specifications of embedded materials.
- technical drawing of the looks of stand (plan, layout, side view and 3D drawing),
- drawing of the base of the stand

NOTE: Side of stand open to communication can't have a wall longer than 30% of its overall length.



G2. EXHIBITOR DATA/ WORK EXHIBITOR

NAME OF EXHIBITOR:

NAME OF EXHIBITOR:

CONTACT PERSON:

CONTACT PERSON:

Phone/Fax:

Gsm:

Phone/Fax:

Gsm:

e-mail:

e-mail:

G3. STAND DATA

BASIS:

APPERANCE

3D VIEW:

TEHNIČKI OPIS:

F4. PRICE OF CERTIFICATION OF STAND AND NOTE:

CERTIFICATION
OF STAND: **2,5 €/m²**



Performer must take clearance for work on the stand before he begins.
Clearance is given in Fair administration.

Signing and certification of this application-contract irrevocably we order these selected services and accept the conditions and general rules of participation.

* VAT not included in prices

DATE

STAMP AND SIGNATURE
OF ORGANISER

DATE

STAMP AND SIGNATURE
OF CLIENT



23.rd INTERNATIONAL ECONOMIC FAIR MOSTAR 2019.

30.03. - 04.04.2020.

Mostarski sajam Inc.
Rodoč bb, 88000 Mostar, BiH
Tel.: + 387 (0) 36 350 080; 350 194
Fax: + 387 (0) 36 350 134; 350 323
e-mail: info@mostar-fair.com
www.mostar-fair.com



22.nd INTERNATIONAL ECONOMIC FAIR MOSTAR 2022.

05.04.- 09.04.2022.

Mostarski sajam Inc.
Rodoč bb, 88000 Mostar, BiH
Tel.: + 387 (0) 36 350 080; 350 194
Fax: + 387 (0) 36 350 134; 350 323
e-mail: info@mostar-fair.com
www.mostar-fair.com

O. COMMON REGULATIONS OF PARTICIPATION

Form O

Common regulations on participation at Mostar Fair consist of binding instructions that regulate registration procedure, exhibiting and business activities at fairs, based on which obligatory relations between the Company Mostarski sajam as a fair organizer and its participants-exhibitors are established.

I REGISTRATION PROCEDURE

Article 1.

Registration for exhibiting is submitted in a standardized registration form filled in block letters, and signed, verified and sent to the fair address. The same procedure is applied when submitting corresponding orders of the fair services.

Deadline for registration is 30 days prior to the opening of the fair. By sending registration form and orders, exhibitors express their consent to the terms of the common regulations on participation at the fair, and thus agree on an obligatory relation with the organizer. Having received a valid registration form, the organizer will send the exhibitor an exhibition stand plan to be agreed on. The exhibitor is to send a written receipt and possible suggestions within 3 days. If not, the plan of the exhibition stand will be considered as accepted. All additional changes will be charged by the organizer at a price increased by 30%.

Article 2.

A registration for exhibiting is valid only for registered companies and implies the obligation of exhibitors to exhibit, from the opening to the closing of the fair, with an authorized officer being present at the exhibitor stand in the whole course of the fair. Withdrawal from the fair before its closing is not allowed. Registered exhibitors cannot sublet the assigned exhibitor stands without permission of the organizer. Otherwise, the exhibitor will be removed from the fair, and he shall be charged full price for all fair orders.

II PAYMENT

Article 3.

Along with registration form for exhibiting, an exhibitor will submit a proof of a settled payment of the required 75 EUR (costs of making a contract and fair catalogue entry)

Organizer is not bound by a registration that doesn't contain the proof of a settled payment.

Article 4.

Having received a valid registration form, the organizer will make out an invoice that should be paid by the exhibitor in full amount, in accordance with the deadline indicated in the invoice, not later than 15 days prior to the opening of the fair. The exhibitor is to bear the costs of the money transaction. In case of dispute on the invoice, the exhibitor is to send it in writing within 5 days, but the part that is beyond the dispute should be paid according to the deadlines indicated from the foregoing subsection. By making out of an invoice, the organizer confirms fulfillment of all the invoiced orders of the exhibitor.

Exhibitors from B&H pay the invoice in KM, and foreign ones in EUR. The organizer reserves the right to adjust prices in case of inflation of EUR.

Article 5.

Depending on available space, the organizer can approve a registration request and payment after the prescribed deadlines, with authority to raise all fair prices, by way of increased costs.

Article 6.

Orders in the course of the fair are to be paid immediately. The organizer reserves the right to keep all exhibits, equipment and other properties of the exhibitor until the exhibitors have discharged all the debts. The organizer reserves the right to sell the kept things if the exhibitors don't meet their obligations within 30 days.

III TAKING OVER AND HANDING OVER EXHIBITION STAND

Article 7.

An exhibition stand is assigned, in principle, according to the order in which registration forms and payments come in. An assigned exhibition stand is taken over by the exhibitor in the Admission Office on the basis of original request and payments of the required amount and total of the fair order.

Article 8.

If the stand design is not ordered from Mostar Fair, the exhibitor is to ask for permission to build their own exhibition area. This permit is approved and issued by Mostar Fair Project Office, at the rate of 2,5 EUR/m². Formal request for construction of a uniquely designed exhibition area is submitted to Mostar Fair (Head office), Rodoč bb, 88 000 Mostar, B&H or to email: biro@mostarski-sajam.com

Article 9.

If the exhibitors don't register at Admission Office, that is if they don't take over the assigned stands at the latest 18 hours prior to the opening of the fair, it will be considered that they withdrew from the exhibiting, and the organizer, in accordance with needs, can rent the space to some other exhibitor. The exhibition stand is taken over and handed over on the basis of an official protocol. Missing rented exhibition stand - material shall be charged to the exhibitor, at a three times higher price on the spot. The exhibitors are obliged to empty the exhibitor stands within 2 days after the formal closing of the fair. Otherwise, it will be done by the organizer to the exhibitors cost.

IV WITHDRAWAL

Article 10.

A registered exhibitor can withdraw from exhibiting under certain conditions, namely:

- 30 days prior to the fair opening, and then the already paid money will be returned, except for the required amount,
- 15 days prior to the opening of the fair, in which case 50% of the paid money is returned, i.e. the invoice is made out for the same amount.

Withdrawal within 10 days before the opening of the fair is not possible and the organizer will keep complete payment, i.e. make out an invoice for the costs. Withdrawal is to be announced in writing, and the deadlines start to be applicable beginning with the date of their coming into the organizer seat.

V SPECIFIC REGULATIONS

Article 11.

In case that the exhibitors arrange the exhibition stands on their own, they are obliged to obey regulations on technical protection, organizer's directions and standard rules of international fairs. When arranging bigger and more complex exhibition stands in person, organizer's consent on the project is required.

Article 12.

The exhibitor is obliged to secure necessary equipment and exhibits from stealing, damage, destruction and other risks, with the official fair insurer. In case that the exhibitors cause damage to the fair organizer, other exhibitor or to a third person, they shall compensate it in accordance with common regulations.

Article 13.

All other business activities, except for exhibiting, are regulated under specific conditions, in a bilateral relation with the organizer and are performed on the basis of a special, written organizer's permission. The regulation from the foregoing subsection relates to the exhibitors also when these activities are performed beyond rented space.

Article 14.

Working time of the fair is from 10:00 to 18:30.

Article 15.

Cleaning common fair premises is obligation of the organizer.

Article 16.

In case of change of the arranged fair dates, caused by circumstances beyond the organizer's control, the organizer is not obliged to reimburse the damage caused to the exhibitors. The organizer will inform exhibitors on the new date of the fair, immediately after the reason for change appears.

Article 17.

All possible litigations are under the jurisdiction of the Mostar Court.

COMMON REGULATIONS ON PARTICIPATION